

Sink Phantom Copper

Kitchen Sinks

Code: 4350 008



DETAILS

Edge/Installation Type Flush-mount | Top-mount

Material AISI 304 stainless steel

Texture Brushed in line

Finish PVD

Coloring Copper

Base 60 cm

Width 51.6 cm

Dimensions 516x416 mm

Bowl dimension 500 x 400 mm

Built-in hole

View technical data sheet

Standard fittings

Fixing hooks, gasket, drain, overflow and siphon, boxed packing

Mixer holes

No standard holes

Drainer

No

Waste fitting

3,5" drain

Number of bowls

1 bowl

FEATURES

Basket 3,5" waste fitting

The drain is equipped with a large 3.5" drain, with the practical basket cap that prevents the discharge of solid parts.

Copper

The Copper finish is obtained by treating steel with a physical process called PVD (Physical Vacuum Deposition) which deposits particles of noble metals on the surface. The result is a unique and refined aesthetic effect, and an improvement of the mechanical properties of the steel which is more resistant to impact and scratches.

Deep bowls

This bowls reach an important depth, over 20 cm, thanks to the advanced production technology, that can be offer great capieny and practicity in all the washing operations.

High thickness

1mm thick steel. A significant thickness, which guarantees the maximum sturdiness and durability.

Perimetral overflow

The overflow is always a security on the Foster sinks that prevents the overflow of water in case of oversights. The perimeter drain solution improves aesthetics thanks to its square and essential shape.

Small radius

Bowls with squared shapes with a modern design and an increased capacity, for a minimal aesthetics connected with an extreme practicity.

TECHNICAL DATA

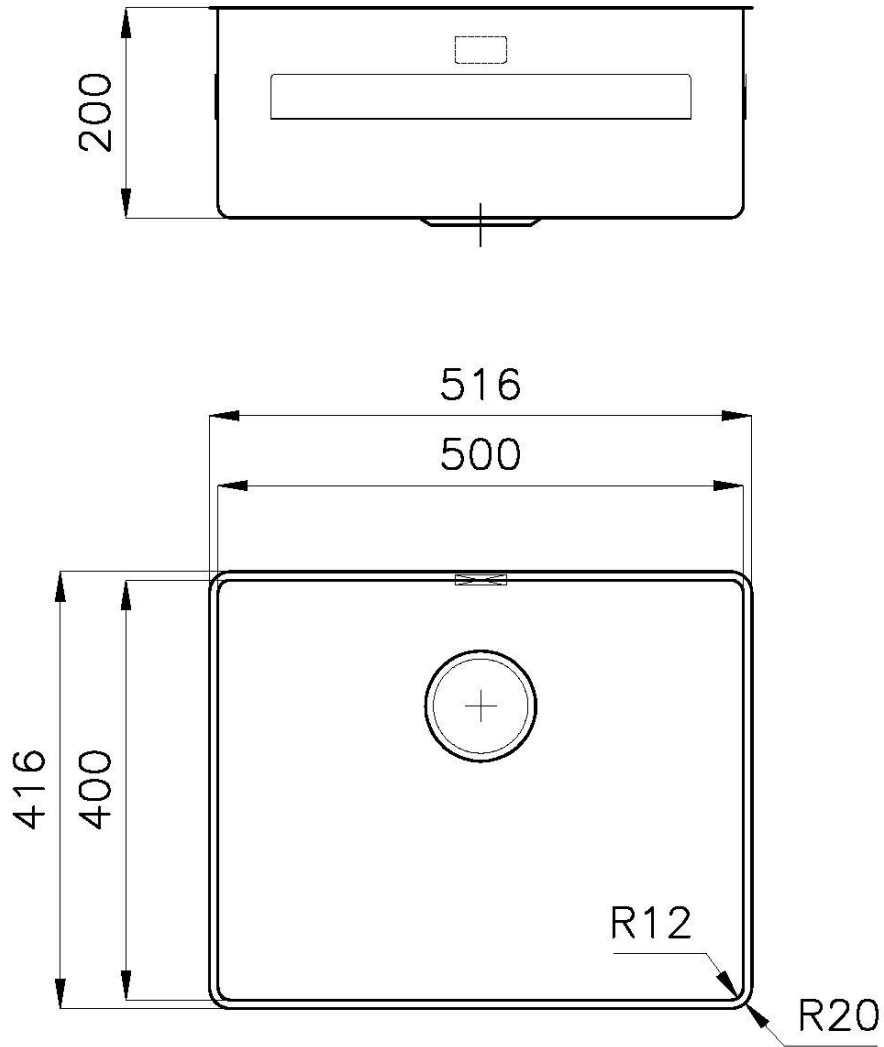



*bordo sottile di soli 8mm
*Thin edge of only 8 mm

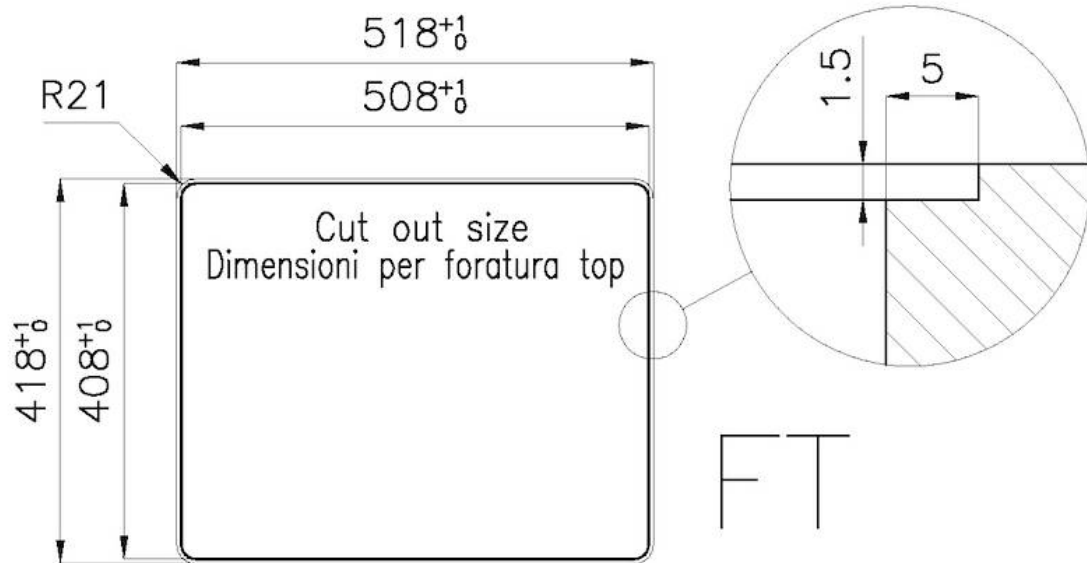

FT

intaglio per il troppo-pieno
solo con top > 15 mm

recess for housing the over-flow
only for top > 15 mm

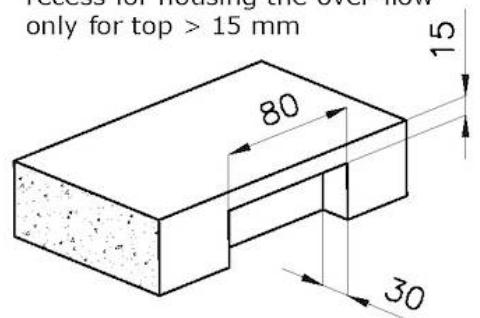
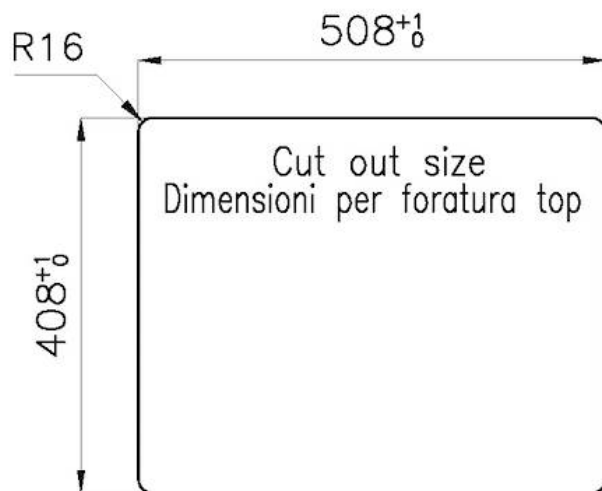

SPT

GALLERY



OPTIONAL ACCESSORIES



Glass chopping board
8631 300



HDPE Chopping board
8657 001



HPDE Twin chopping board
8644 101

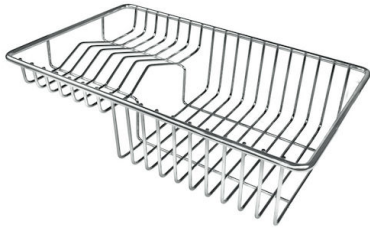

Stainless steel plate rack
8100 303
* only in combination with the accessory
8644 101



Stainless steel plate rack
8100 201



White bowl
8153 100



Black grid
8100 617

Black grid
8100 652



**Graters kit with ring-holder and
food collection tray**
8159 101
* only in combination with the accessory
8644 101



**Iroko-wood sliding chopping board
with stainless steel colander**

8644 044



Stainless steel perforated tray

8151 000

* only in combination with the accessory
8644 101



**Stainless steel perforated tray PVD
Copper**

8151 008

* only in combination with the accessory
8644 101



**Stainless steel perforated tray PVD
Gold**

8151 009

* only in combination with the accessory
8644 101



**Stainless steel perforated tray PVD
Gun Metal**

8151 006

* only in combination with the accessory
8644 101

OPTIONAL AUTOMATIC WASTE FITTINGS



Automatic waste fitting - PM
8407 113



Space automatic waste fitting - PA
8407 108



Space automatic waste fitting - PE
8407 109



**Space Light automatic waste fitting
- PL**
8407 117



**Space Push automatic waste fitting
- PP**
8407 116